

温馨提示：  
盘面输出转速高于100rpm/min.请订货前说明.

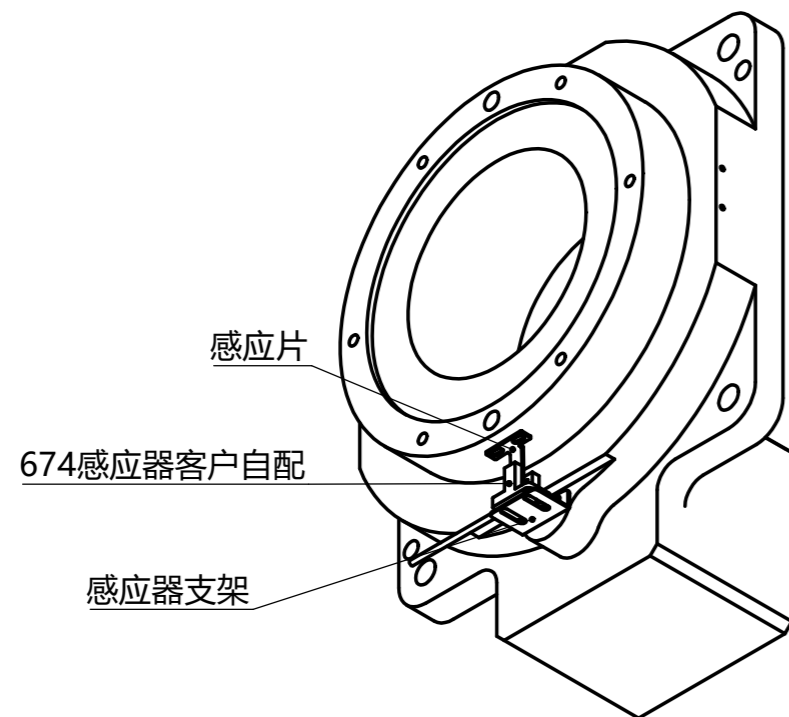
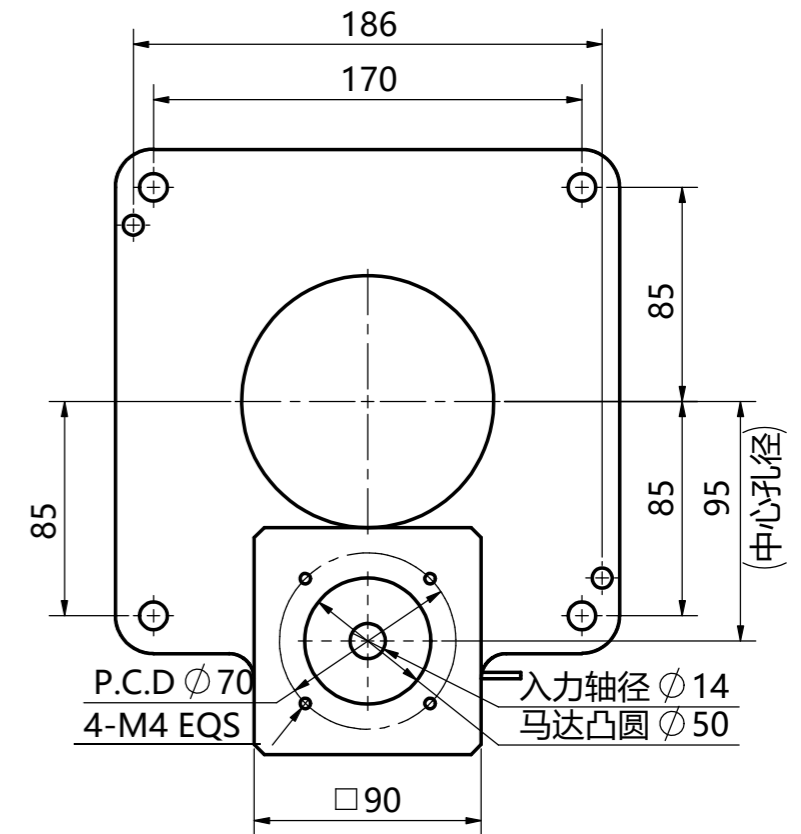
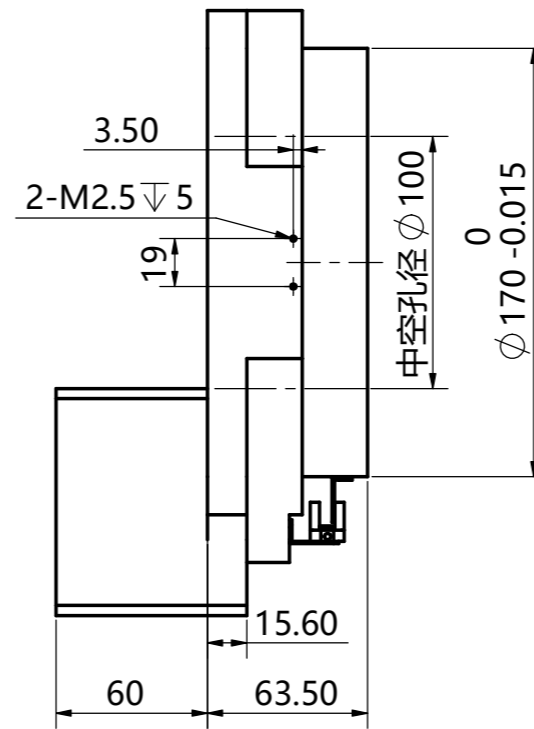
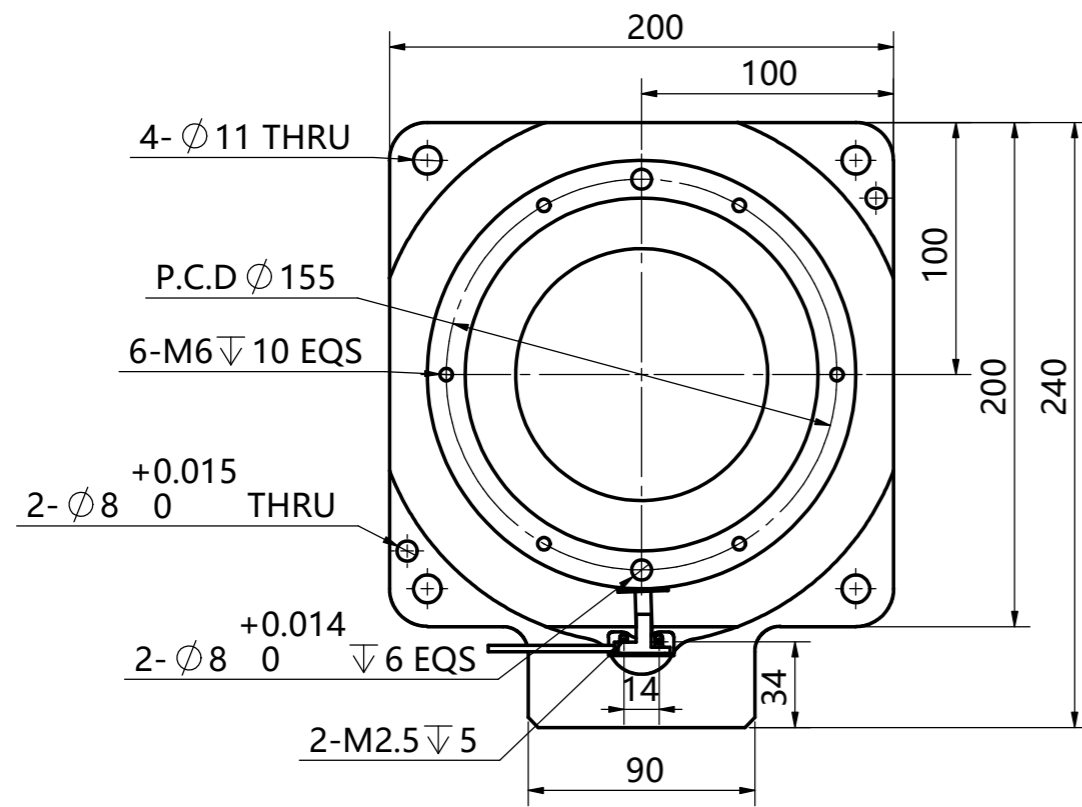

技术参数	规格型号		
旋转平台轴承	交叉滚子轴承		
减速比 i	1: 18(不含减速机)	容许轴向压力 N	2000
容许输入转矩 N.m	$\leq 60$	旋转平台平面度 mm	0.01
容许盘面转速 rpm	100	旋转平台同心度 mm	0.01
重复定位精度 arc-sec	$\pm 15$	精度寿命 hr	20000(间歇运转)
定位精度 arc-sec	$\pm 30$	保护等级 IP	40

2023/06/10存档